

# MediaTek Overview

Q4 2022

# MediaTek at a Glance

**THIS CHIP CHANGES EVERYTHING**

# Enrich & Enhance Everyone's Life

Our mission is to be a **change catalyst**, empowering our partners with **smart technology solutions** that will inspire them to connect with the “next billion” people.

By building technologies that help connect individuals to the world around them, we are enabling people to expand their horizons and more easily achieve their goals.

We believe anyone can achieve something amazing. And we believe they can do it every single day. We call this idea **Everyday Genius** and everything we do is dedicated to making it possible.

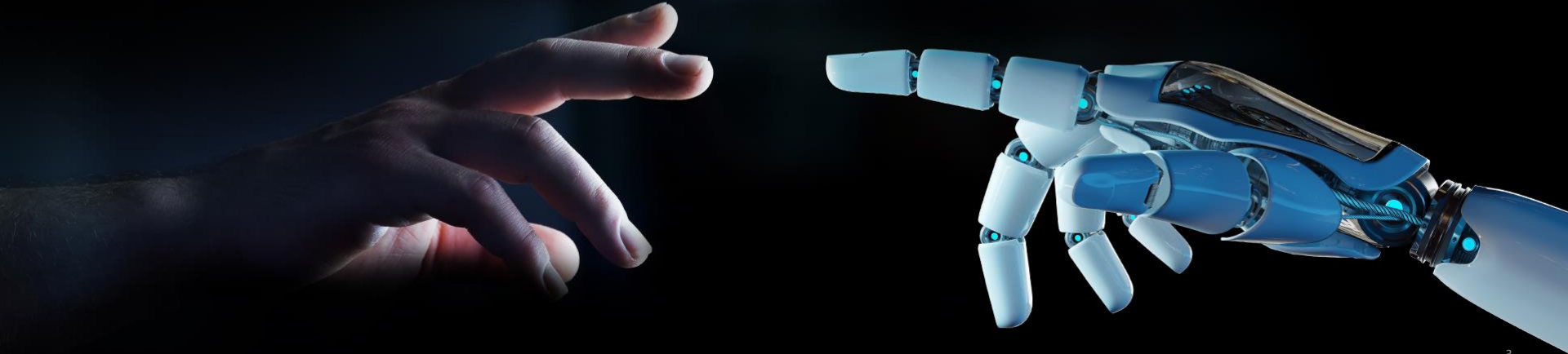

**MEDIATEK**  
GROUP

**MEDIATEK**  
MediaTek Inc.

**AIROHA**  
Airoha Technology Corp.

**RICHTEK**  
Richtek Technology  
Corp.



# 4<sup>TH</sup>

## **World's fourth largest fabless IC design company (by revenue) in 2021**

Headquarters in Taiwan  
Publicly listed on the Taiwan Stock Exchange Market  
(ticker number 2454)

Source: TrendForce, March 2022

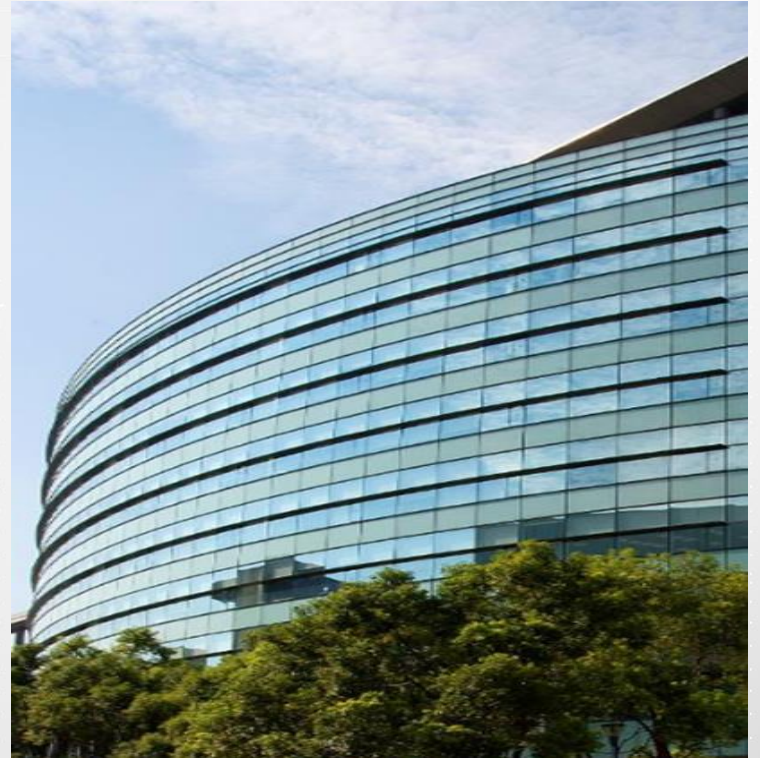

# 7<sup>TH</sup>

## Largest semiconductor company worldwide in 2021 (by revenue)

Raised from ranking #8 in 2020 with a 60.2% growth rate

Source: Gartner's Market Share Analysis: Semiconductors, Worldwide, 2021

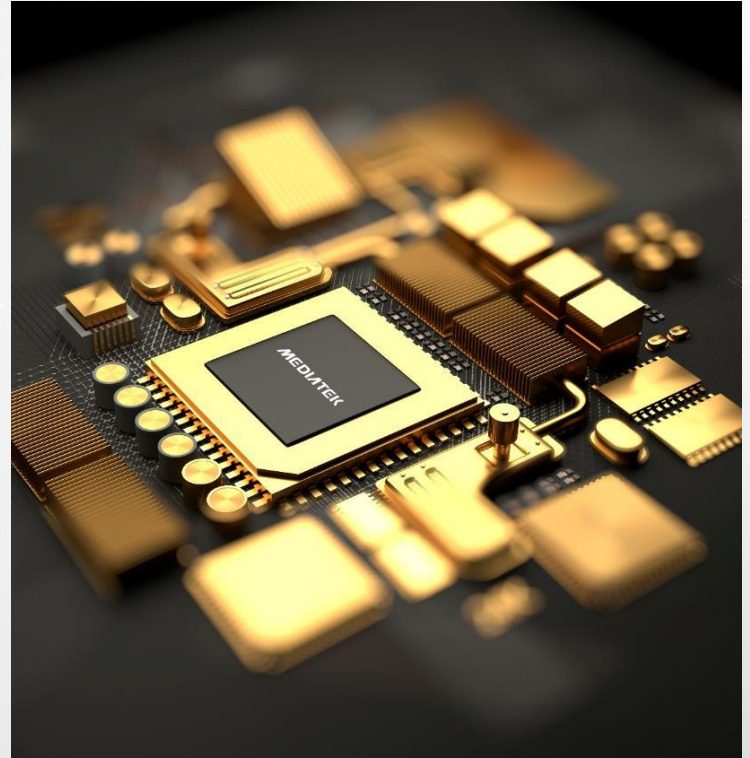

# 17.6<sub>BN</sub>

## MediaTek Group Revenue in 2021 (USD)

or TWD 493.4 billion.

Key product categories: mobile communication, intelligent devices, analog, wireless & wired connectivity, and IoT



# Our Products



# Diversified Product Portfolio

2022 Q2 status by revenue

54%  
Mobile Phone

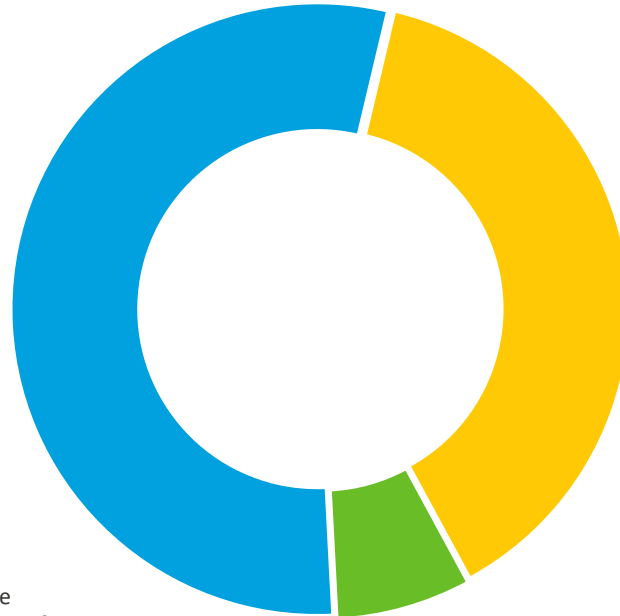

38%  
Smart Edge Platforms

7%  
Power IC

*\*Sums may not equal 100% due to rounding.*

- **Mobile Phone:** 5G/4G/3G smartphone and feature phone
- **Smart Edge Platforms:** Wireless/wired connectivity and SoC for router, broadband, PON, laptop, wireless headset, smart speaker and automotive; ARM-based computing and IoT; TV; customized service for consumer/enterprise platforms
- **Power IC:** Power IC

# Diversified Product Portfolio

## cross-platform, global market leadership

revenue ratio\*: **54%**

**38%** **7%**

Mobile Phone		Smart Edge Platforms							Power IC
Smartphone	Feature Phone	Arm-based Chromebook	Android Tablet	Voice Assistant Device	Connectivity, Broadband & Networking	Smart TV & Digital TV	Optical Drive & BD Player	ASIC	Power Management
									
<b>#1</b>	<b>#1</b>	<b>#1</b>	<b>#1</b>	<b>#1</b>	<b>#1</b>	<b>#1</b>	<b>#1</b>	growing	growing

Source (ranking by 2021 market share): Strategy Analytics, Gartner, IDC, IC Insight, iSuppli and MediaTek company data.

\*based on 2022 Q2 revenue ratio (Sums may not equal 100% due to rounding).

# MediaTek Platforms

enabling an everywhere connected experience



Gaming



Automobile



Connectivity



Smartphone



Tablet



Digital TV



Wearable



Optical Drive



AR / VR



DC / Cloud Switch

# Connected on the Move

total solution provider for mobile computing

## Automotive



Infotainment



eCockpit



Telematics



Smart Rear Mirror



Navigation



mmWave Radar

## Smart Devices



Chromebook



Smartphone



Tablet



Smartwatch



Wearable



Sharing Bike



Drone



Smart Meter

## Others

# Connected at Home

total solution provider creating a smarter home

## Home Entertainment



## Smart Appliances



## Connectivity & Networking

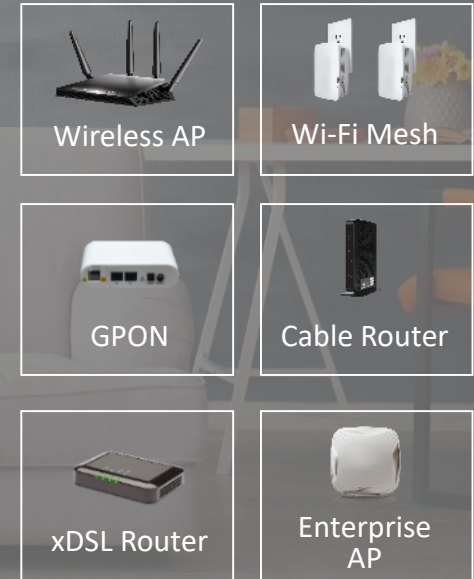

# Aiming at Future

shift in scale reflecting the potential opportunity

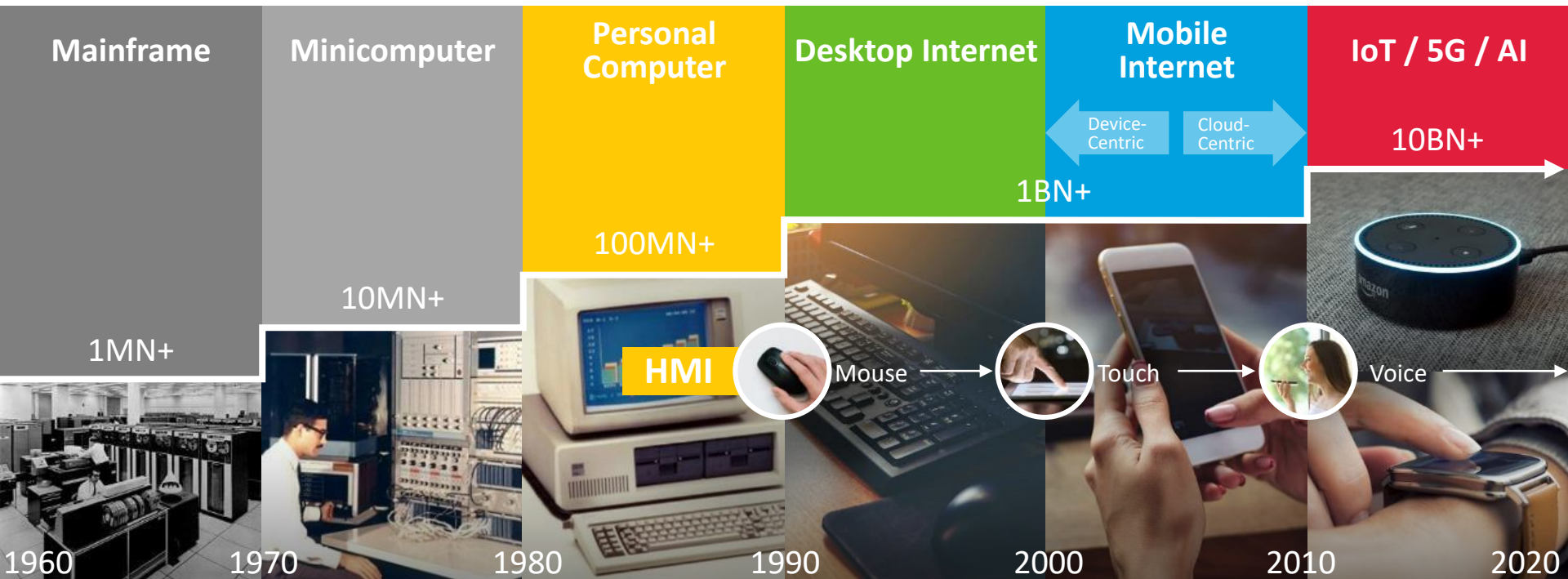

# “Make in Vietnam”

# MediaTek: Vietnam customers





# Easy Mesh Access Point – EW12SX

## Chipset

CPU: MediaTek MT7621DAT

Dualcore 880MHz

Chipset 2G: MT7603EN

Chipset 5G: MT7613BEN

## Power

DC 12V – 1A

## Memory

128MB DDR2 RAM

16MB NOR Flash

## Interface

02 Gigabit Ethernet port

## Button

01 Reset button

01 WPS

## Led

01 led

## Wifi

802.11 a/b/g/n/ac

2.4Ghz: MIMO 2x2

Phy rate: 300 Mbps

5Ghz: MIMO 2x2

Phy rate: 867 Mbps

Bandwidth 20/40/80 Mhz

MU-MIMO

Beamforming

TXPW: 20dbm per chain @2.4GHz

20dBm per chain @5GHz

## Antenna

Internal Omni antenna

Dual band 2x2

3dBi gain

## OS

Linux

**VNPT Technology**  
A MEMBER OF VNPT



# Easy Mesh Access Point – EW30ST

## Chipset

CPU: MediaTek MT7981

Dualcore 1.3GHz

Chipset WiFi: MT7976

## Power

DC 12V – 1.5A

## Memory

256MB DDR3 RAM

32MB NOR Flash

## Interface

02 Gigabit Ethernet port

## Button

01 Reset/WPS button

## Led

05 led

## Wifi

802.11 a/b/g/n/ac/ax

2.4GHz: MIMO 2x2

Phy rate: 573.5 Mbps

5GHz: MIMO 2x2

Phy rate: 2471.9 Mbps

Bandwidth 20/40/80/160 Mhz

MU-MIMO

Beamforming

TXPW: 20dbm per chain @2.4GHz

21dBm per chain @5GHz

## Antenna

Internal Omni antenna

Dual band 2x2

3dBi gain

## OS

Linux

**VNPT Technology**  
A MEMBER OF VNPT



# Enterprise Router – ER6221

## Chipset

CPU: MediaTek MT7621 Dualcore  
880MHz  
Chipset WiFi: MT7615

## Power

DC 12V – 1.5A

## Memory

512MB DDR3 RAM  
64MB NOR Flash

## Interface

05 Gigabit Ethernet port  
02 Micro USIM slot (Active-Active)  
01 Micro SD slot

## Button

01 Power on/off  
01 Reset button  
01 WPS

## Led

10 led

## Wifi

802.11 a/b/g/n/ac  
2.4Ghz: MIMO 2x2  
Phy rate: 300 Mbps  
5Ghz: MIMO 2x2  
Phy rate: 867 Mbps  
Bandwidth 20/40/80 Mhz  
TXPW: 23dbm per chain @2.4GHz  
23dBm per chain @5GHz

## Cellular

02 Internal LTE Modules  
TDD-LTE B34/B38/B39/B40/B41  
FDD-LTE B1/B3/B5/B8  
Category 4 (150Mbps/50Mbps)  
UMTS/HSPA+,GPRS/Edge,EVDO

## Antenna

02 Internal WiFi Omni antenna  
Dual band 2x2, 3dBi gain  
04 External Cellular Omni antenna  
3G/LTE, 1T2R, 5dBi gain

## OS

Linux

**VNPT Technology**  
A MEMBER OF VNPT



# VNT Tab8

CPU	MT8765A
RAM	3 GB
Flash	32 GB eMMC Flash
Kích Thước	134 x 214 x 12 mm
Màn Hình	8 inches, 800 * 1280 IPS
Camera	2.0M (Front) 5.0M (Rear)
Pin	Li-ion 5000mAh
Nguồn	5V – 1.5A
Chức Năng	
GPS	Có
FM	Có
Loa Ngoài	Có
Micro	Có
Chế độ rung	Có

**VNPT Technology**  
A MEMBER OF VNPT



- **Ethernet port:** 4 x 10/100/1000 base-TX.
- **Optical port:** DL/UL:2.5/1.25 Gbps
- **Antenna:** 2 x 2 MIMO or 3 x 3 MIMO
- **Wifi:** Dual band 2.4/5GHz
- **Standard:** 802.11b/g/n/ac/ax
- Allowing connection to peripherals through communication standards such as USB, VoIP, Ethernet
- Performing data transmission by wireless signal (Wifi) between GPON equipment and terminals of customers.
- Supporting dualband feature, working on both 2.4 GHz and 5 GHz transceiver frequencies.
- Ready to deploy Wifi MESH network for customers.

**viettel**  
high tech



## Achievements:

- ❖ ***Awards have been achieved such as: Golden Award- IT World Awards 2021 in the category “Innovative products, high-tech blocks”.***
- ❖ ***Products have been deployed in the markets of Vietnam with volume ~ 1M devices.***

- **Ethernet port:** 3 x 10/100/1000 base-TX.
- **Wifi:** Dual band 2.4/5GHz
- **Standard:** 802.11b/g/n/ac/ax
- **Supporting** 2 x 2 MIMO technology on 2.4 GHz and 5GHz bands, allowing connection speed up to 300 Mbps with n standard and 867 Mbps with ac standard
- Two simultaneous radio streams provide a high-speed Wif connection to a large number of users.
- Smart antennas are optimally designed in accordance with the used space, helping to increase coverage and stability
- Ready to deploy Wifi MESH network for customers.

**viettel**  
high tech



### **Achievement:**

❖ ***Products have been deployed in the markets of Vietnam with volume ~ 100K devices.***

# G350 SYSTEM on MODULE



A highly integrated Edge AI platform powered by Mediatek Genio G350

## SOM-G350

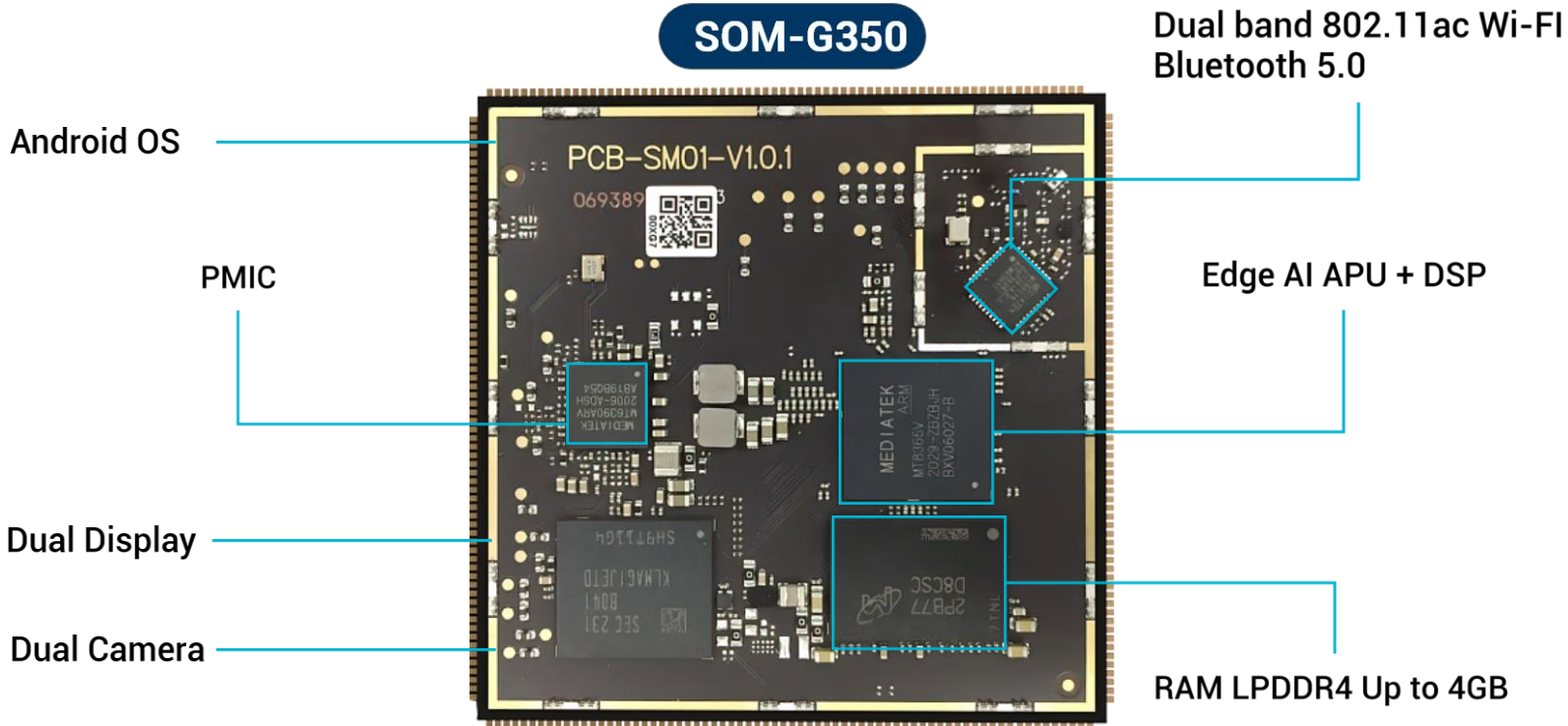

## KIT G350



## Carrier Board

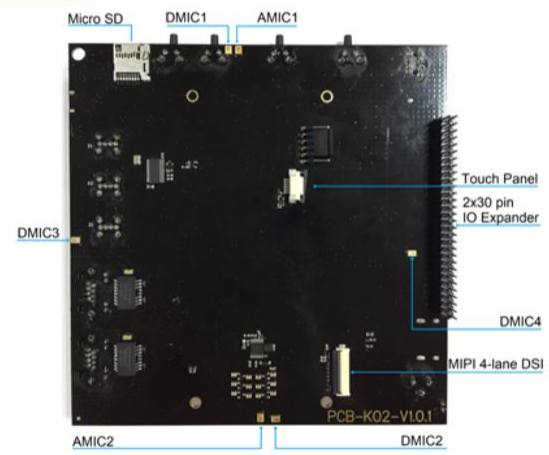
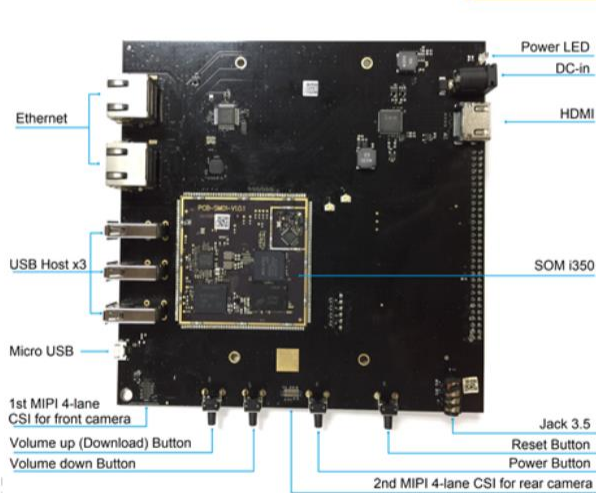



AI BOX

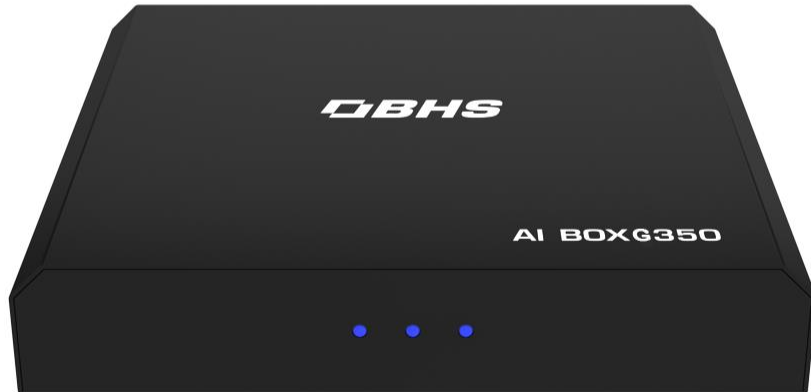

## Specification

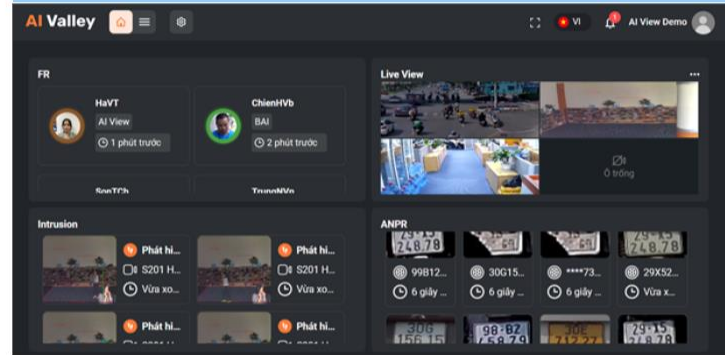

- Ram: Up to 4G
- Lan Ethernet: 100 Mbps
- Digital I/O: 2 In, 2 Out
- Camera: 2 Channel
- Ready Platform for Edge AI

# Go Global with MediaTek

# 50

**We have more than 50 offices  
with 17,000+ employees globally**

MediaTek Group includes: Airoha (達發), Richtek (立錡)



# MediaTek Group Global Presence

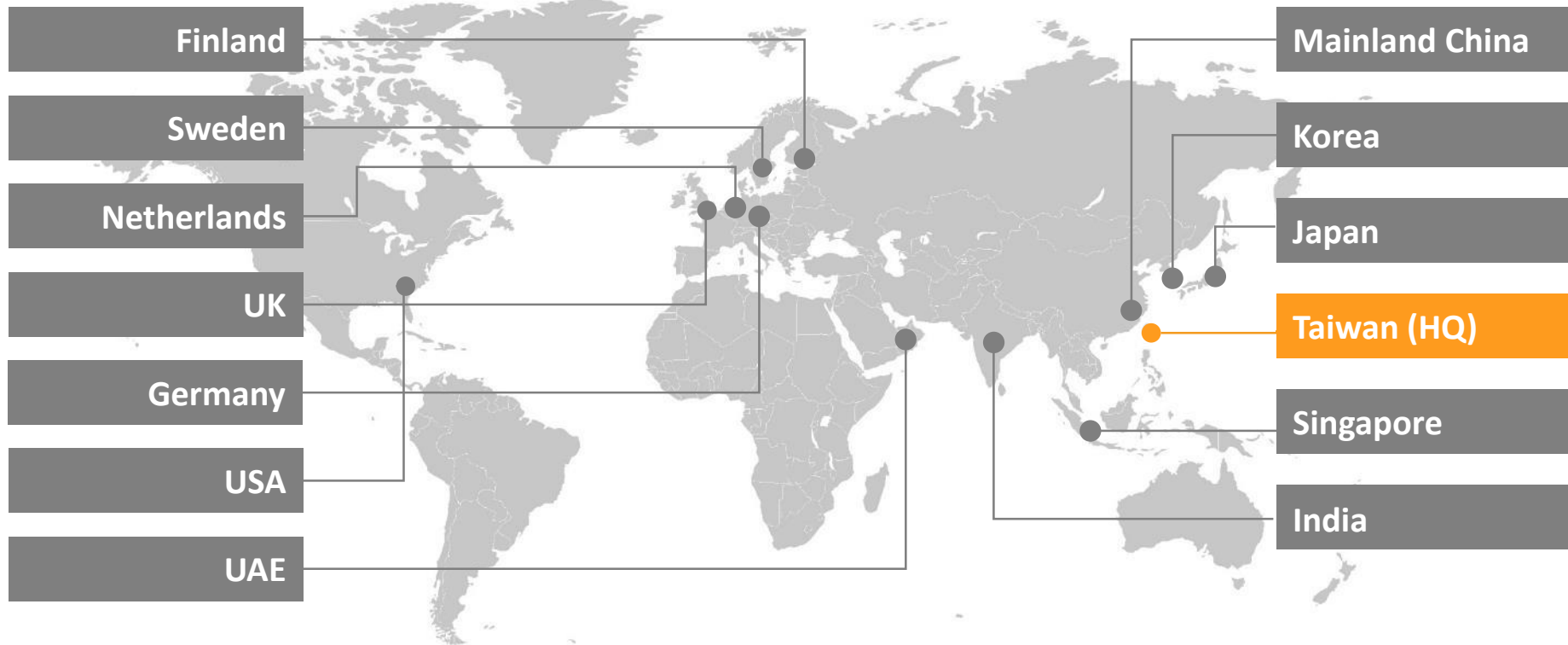

# Leading Core Technologies

## Enabling Intelligent Devices with Tier-1 Customers



# Global Partners

Enabling an Everyday Genius Experience



HONOR



Lenovo



LG



Microsoft



motorola  
a Lenovo company

NETFLIX

NETGEAR



Panasonic

PHILIPS

Pioneer

POLAR

SAMSUNG

SONOS

SONY

Telefonica

Tencent 腾讯

T-Mobile

TOSHIBA

TP-LINK

verizon

vivo

VIZIO

vodafone



YAMAHA

# MediaTek Ecosystem

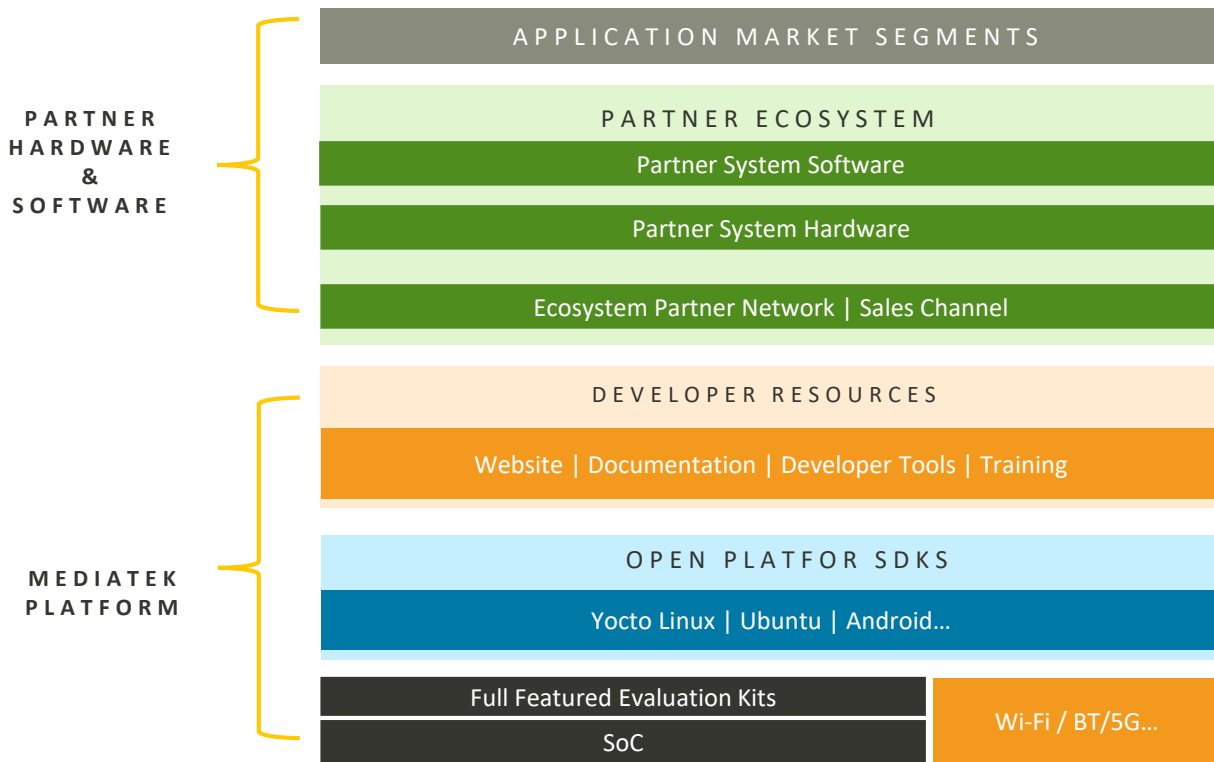

# Go Global with MediaTek

**MEDIATEK**

## “Make in Vietnam”

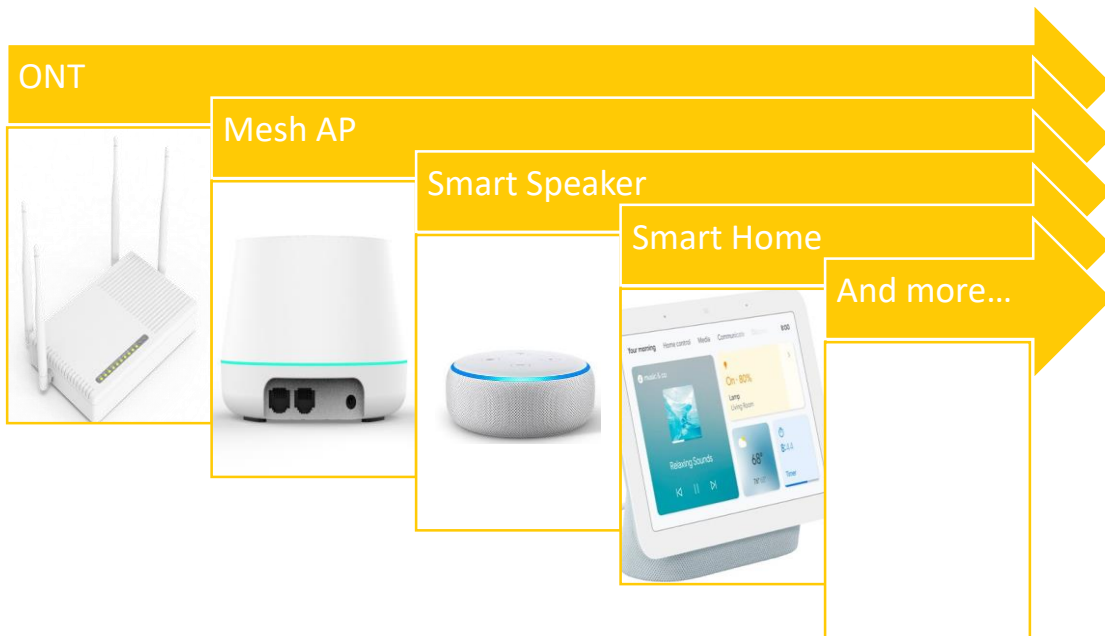

## Global Market





# Thank You

Question & Answer

**MEDIA TEK**

*everyday genius*